

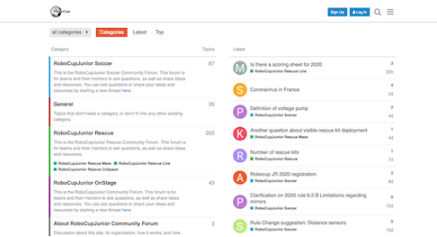

RoboCupJunior Rescue Maze Rules 2025 Draft

RoboCupJunior Rescue Committee 2025		
Chair	Diego Garza Rodriguez	Mexico
	Stefan Zauper	Austria
	Csaba Aban Jr.	Hungary
	Joann Patiño	Panama
	Ryo Unemoto	Japan
	Alexander Jeddeloh	Germany
	Gonzalo Zabala	Argentina

RoboCupJunior Exec 2025		Trustees representing RoboCupJunior	
Roberto Bonilla	USA	Luis José Lopez Lora	Mexico
Marek Šuppa	Slovakia	Julia Maurer	USA
Marco Dankel	Germany		
Margaux Edwards	Australia		
Rui Baptista	Portugal		
Tatiana Pazelli	Brazil		
Tom Linnemann	Germany		

Official Resources

RoboCupJunior Official Website	RoboCupJunior Official Forum	RCJ Rescue Community Website
 <p>https://junior.robocup.org</p>	 <p>https://junior.forum.robocup.org</p>	 <p>https://rescue.rcj.cloud</p>



Corrections and clarifications to the rules may be posted on the forum before updating this rule file. It is the responsibility of the teams to review the forum to have a complete vision of these rules.

Before you read the rules



Please read through the [RoboCupJunior General Rules](#) before proceeding with these rules, as they are the premise for all rules. The English rules published by the RoboCupJunior Rescue Committee are the only official rules for RoboCupJunior Rescue Maze 2025. The translated versions each regional committee can publish are only referenced information for non-English speakers to understand the rules better. It is the responsibility of the teams to read and understand the official rules.

Scenario

The land is too dangerous for humans to reach the victims. Your team has been given a difficult task. The robot must be able to carry out a rescue mission in a fully autonomous mode with no human assistance. The robot must be durable and intelligent enough to navigate treacherous terrain with hills, uneven land, and rubble without getting stuck. The robot must search for victims, dispense rescue kits, and signal the position of the victims so the humans can take over. Time and technical skills are essential! Come prepared to be the most successful rescue team.

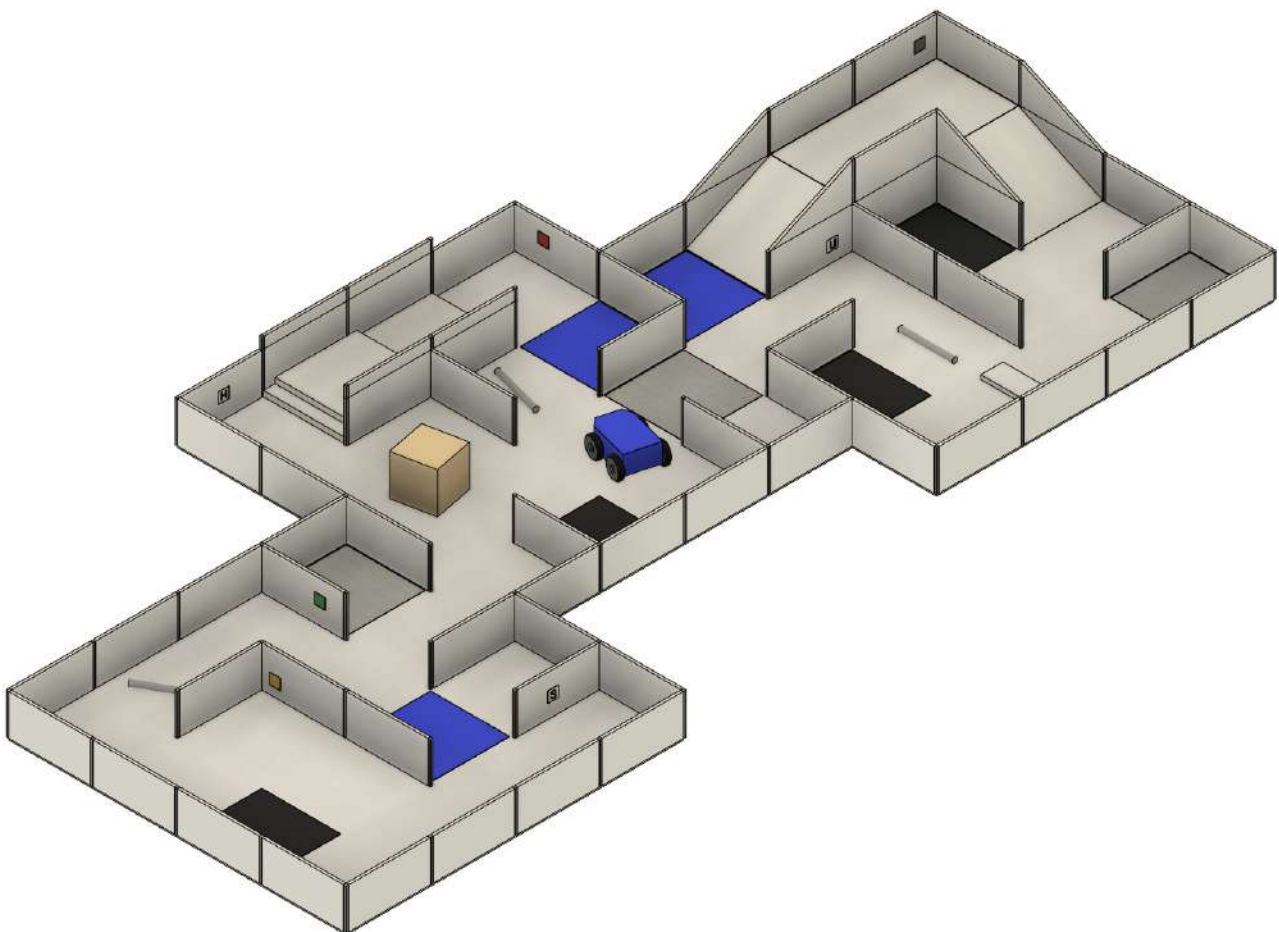

Summary

The robot needs to search through a maze for victims. The robot is not supposed to find the fastest path through the labyrinth; instead, it should explore as much of the maze as possible. The robot will be awarded -5, 10, 15, or 30 points for each colored or letter victim detected, dependent on its location in the field. Suppose the robot can successfully deliver a rescue kit close to a victim. In that case, it will earn an additional 10 points per rescue kit. The number of maximum extra points depends on the type of victim.

- 20 points for harmed letter victims
- 10 points for stable letter victims
- No additional points for an unharmed letter victim
- 20 points for a red-colored victim
- 10 points for a yellow-colored victim
- No additional points for a green-colored victim

If the robot is stuck in the maze, it can be restarted at the last visited checkpoint. A reflective floor indicates checkpoints, so the robot can save the position to a map (if it uses a map) in a non-volatile medium and restore it in case of a restart. The robot must also avoid areas with a black floors.

If the robot can find its way back to the beginning of the maze after exploring the whole maze, it will receive an exit bonus. The robot will also earn a reliability bonus if the robot can exit the maze with a minimum number of restarts. Suppose the robot can find its way back to the beginning after exploring the maze. In that case, it will receive ten bonus points per identified victim as an exit bonus.

The robot can earn additional points by navigating the following obstacles:

- 10 points for going up or down a ramp
- 10 points for each visited checkpoint
- 5 points for passing through each tile with speed bumps
- 5 points for navigating a set of stairs

Changes from the 2024 RoboCupJunior Rescue Maze Rules

- Changed 0.4 to 0.6
- Changed "0.4 x (ENGINEERING JOURNAL SCORE) / (BEST ENGINEERING JOURNAL SCORE)" to "0.2 x (VIDEO SCORE) / (BEST VIDEO SCORE)"
- Changed "0.7" to "0.6"
- Changed 0.1 to "0.2"
- Added "Ramps must NOT have a drop-off immediately following a rise section, creating a peak-like structure, or vice versa."
- Changed "Speed Bumps, Debris, Obstacles, and Stairs" to "Speed Bumps, Obstacles, and Stairs"
- Changed "2" to "1"
- Added "Speed bumps are not allowed to be placed on ramps or stairs."
- Added "Stairs may be used to change the level of the floor, similar to a ramp."
- Added "Dangerous Zone"
- Added "Terms and Definitions"
- Added "Robots like drones or hovercrafts are prohibited in the challenge due to safety reasons."
- Added "The robot must be equipped with one specific LED or display that is dedicated only for identifying victims. The LED or display must be clearly visible to the referee."
- Changed "an indicator" to "with the specific LED or Display (see <<led-display,3.3.11>>) that is clearly"
- Added "The blink interval (ON: 500ms, OFF: 500ms) must be followed to successfully identify a victim."
- Changed "a set of stairs in either direction" to "up or down the stairs"
- Changed "set of stairs" to "direction (up or down)"
- Changed "and then onto the bottom tile on the other side of the stairs without assistance" to "(or vice-versa) and is entirely within the horizontal tile without toppling over."
- Changed "The 'exit bonus' condition is satisfied when the robot returns to the starting tile and stays there for at least 10 seconds to complete the scoring run." to "The 'exit bonus' condition is satisfied when the robot returns to the starting tile. On the starting tile, the robot has to blink (ON: 1s, OFF: 1s) with the same LED or display that is used to identify a victim (see <<led-display,3.3.11>>) for at least 10 seconds."
- Changed "Engineering Journal" to "Video"
- Added "Any external contact during the Technical Challenge is prohibited; non-team members are not allowed to take place on the competition area or to help the competitors remotely."
- Added "It is highly recommended that teams bring some kind of communication hardware or think about a communication mechanism for this challenge."
- Changed "Engineering Journal" to "Video (see <<documents-video,6.3.7>>)"



- Changed "TDP should describe your team's project planning, robot's mechanical and electronics design, your software architecture and solutions and, the applied process on performance evaluation." to "The competition organizer will ask the team to fill out the web form or ask to submit a PDF file. All teams must strictly follow the guidance on the web form or, in the case of PDF submissions, strictly follow the template provided. If a team does not follow this guidance / template (including but not limited to the different sections, fonts, sizes and lengths) the score for the document will be 0 and is not going to be evaluated."
- Deleted "Engineering Journals should demonstrate your best practices in the development process. A guide for the Engineering Journal format and rubrics are available on the [https://junior.robocup.org/rcj-rescue-maze/\[RoboCupJunior Official website\]](https://junior.robocup.org/rcj-rescue-maze/[RoboCupJunior Official website])."
- Added "All teams must create and submit a Video before the competition. The Video should be short and showcasing the work of the team. These videos will be presented during the competition and should summarize the key aspects of the team's project, design process, and innovations. A guide for the video format and rubrics are available on the [https://rescue.rcj.cloud/documents/\[RoboCupJunior Rescue Community Website\]](https://rescue.rcj.cloud/documents/[RoboCupJunior Rescue Community Website])."



Contents

1. RoboCupJunior International 2025 General Rules	8
2. Code of Conduct	10
2.1. Spirit	10
2.2. Fair Play	11
2.3. Behavior	11
2.4. Mentors	11
2.5. Ethics and Integrity	11
2.6. Sharing	12
3. Field	12
3.1. Description	12
3.2. Floor	13
3.3. Path	13
3.4. Speed Bumps, Obstacles, and Stairs	14
3.5. Dangerous Zone	15
3.6. Victims	16
3.7. Rescue Kits	17
3.8. Environmental Conditions	17
4. Robots	18
4.1. Terms and Definitions	18
4.2. Control	18
4.3. Construction	18
4.4. Team	19
4.5. Inspection	19
4.6. Violations	20
5. Play	20
5.1. Pre-game Practice	20
5.2. Humans	20
5.3. Start of Game	21
5.4. Scoring Run	21
5.5. Lack of Progress	22
5.6. Scoring	22
5.7. End of Game	24
6. Competition	24
6.1. Rounds & Scoring	25
6.2. Technical Challenge	26
6.3. SuperTeam Challenge	26
7. Open Technical Evaluation	26



7.1. Description	26
7.2. Evaluation Aspects	27
7.3. Documents	27
7.4. Sharing	28
8. Conflict Resolution	28
8.1. Referee and Referee Assistant	28
8.2. Rule Clarification	28
8.3. Special Circumstances	28

1. RoboCupJunior International 2025 General Rules

These rules apply to the international RoboCupJunior competition. However, regional, super-regional, and local tournaments may have variations or adaptations to these rules to suit their specific competition needs. It is important to check with the organizers of the tournaments you are participating in to confirm which exact rules will be in use.

If teams are unsure about any aspects of the General Rules or specific League Rules, they are encouraged to inquire via the official RoboCupJunior Forum for clarification: <https://junior.forum.robocup.org/>

1.1. Team Size

Minimum Team Size: Teams must consist of at least 2 members.

Maximum Team Size:

- Soccer and Rescue Leagues: 4 members.
- OnStage League: 5 members.

Shared Members and Robots: No team member(s) or robot(s) may be shared between teams.

1.2. Team Members

Age Requirements for RoboCupJunior International Tournaments:

- Minimum age: 14 years old.
- Maximum age: 19 years old.
- Age is counted as of July 1st for the international event each year.

Entry Leagues: RoboCupJunior Entry leagues and other "Primary" divisions (where minimum age may vary) are not run at the international competition but feature in many regions and SuperRegional tournaments.

Technical Roles: Every team member must have a defined technical role (mechanical/design, electrical/sensing, software etc.) and should be able to explain their role during technical judging.

1.3. Robot Communication

Permitted Communication: Communication between robots during gameplay is allowed as long as it uses the 2.4GHz spectrum and its power output does not exceed 100 mW EIRP under any circumstances.

Responsibility: Teams are responsible for managing their robot communication. Spectrum availability is not guaranteed.



Component Communication: Communication between components of the same robot is permitted under the general guidelines.

League Adaptability: Each league may modify the robot communication rules to ensure they meet their specific requirements.

1.4. Safety and Power Requirements

Electrical Power:

- Robots must not use mains electricity.
- Maximum allowed voltage: 48V DC or 25V AC RMS.
- Voltage must be easily measured during inspections, and measuring points must be covered for safety or designed with safety considerations in place.

Battery Safety:

- Lithium batteries must be stored in safety bags, and charging must be supervised by team members in competition areas.
- Teams must follow safety protocols, including battery fire handling and evacuation procedures.

Robot Safety Design:

- **Power Management:** Secure batteries, safe wiring, and emergency stop functionality.
- **Mechanical Safety:** No sharp edges, pinch points, or other hazards. Actuators must be appropriate for the robot's size and function.
- **Hazardous Behavior:** Teams must report potentially dangerous robot behaviors at least two weeks before the event.

1.5. RCJ Team Posters

Purpose: Posters are a tool for sharing robot designs and insights with judges, teams, and the public. Posters will be hung in public competition areas in the venue and digital copies or photographs will be shared by RCJ after the competition.

Size: Posters must be no larger than A1 size (60 x 84 cm).

Content: Posters should summarize design documents and present the robot's capabilities in an engaging format.

1.6. Technical Description Video (See League Documentation)

Content:

- **Robotic Demonstration:** Show fully functional robot systems to highlight technical aspects.
- **Design Process:** Explain design choices and team problem-solving approaches.



- **Presentation:** Clear and high-quality, explaining innovative or unusual techniques.
- **Innovation & Sustainability:** Highlight new technologies and sustainable practices.

Submission: Guidelines will specify video length and deadlines per league.

1.7. Sharing Team Resources

Sharing: Materials submitted by teams as part of the documentation submission will be shared on GitHub repositories for the leagues: <https://github.com/robocup-junior>

Credit: Teams must credit creators of external work and adhere to licensing rules. The focus should remain on personal growth and learning.

1.8. Plagiarism Guidelines

External Code Use: Teams are allowed to use external code but must credit the original creators.

Learning Priority: Teams should prioritize learning and not use complete solutions from others. Always pay attention to licensing rules.

1.9. Bill of Materials (BOM)

Submission: Teams must submit a BOM listing major components and materials used.

Details: The BOM must include:

- Component name/description (e.g., part number).
- Supplier/source of the component (including PCBs/machined components).
- Status (new/reused).
- Kit or custom-built.
- Price.

Template: A standardized BOM template will be provided with the league documentation submissions for the international competition.

2. Code of Conduct

2.1. Spirit

1. It is expected that all participants (students and mentors alike) respect the aims and ideals of RoboCupJunior as set out in our mission statement.
2. The volunteers, referees, and officials will act within the event's spirit to ensure the competition is competitive, fair, and, most importantly, fun.
3. **It is not whether you win or lose but how much you learn that counts!**

2.2. Fair Play

1. Robots that cause deliberate or repeated damage to the field will be disqualified.
2. Humans who cause deliberate interference with robots or damage the field will be disqualified.
3. It is expected that all teams aim to participate fairly.

2.3. Behavior

1. Each team is responsible for verifying the latest version of the rules on the RoboCupJunior Official website and additional clarifications/corrections on the official forum made by the RoboCupJunior Rescue Committee before the competition.
2. Participants should be mindful of other people and their robots when moving around the tournament venue.
3. Participants are not allowed to enter setup areas of other leagues or teams unless explicitly invited to do so by team members.
4. Teams will be responsible for checking updated information (schedules, meetings, announcements, etc.) during the event. The RoboCupJunior Rescue Committee will provide updated information on notice boards in the venue, the local competition website, or the RoboCupJunior website if possible.
5. Participants and their companions who misbehave may be asked to leave the venue and risk being disqualified from the tournament.
6. Referees, officials, tournament organizers, and local law enforcement authorities will enforce these rules equally to all participants.
7. Teams are expected to be at the venue early on the setup day as important activities will occur. These activities include but are not limited to registration, participation raffle, interviews, captains, and mentor's meetings, among others.

2.4. Mentors

1. Non-team members (mentors, teachers, parents and other family, chaperones, translators, and other adult team members) are not allowed in the student work area.
2. Mentors are not permitted to be involved in building, repairing, or programming their team's robots before and during the competition.
3. In the first instance, mentor interference with robots or referee decisions will result in a warning. If this behavior recurs, the team could face a possible elimination from the tournament.
4. Robots have to be the work of the students. Any robot that appears identical to another robot may be prompted for re-inspection.

2.5. Ethics and Integrity

1. Fraud and misconduct are not condoned. Fraudulent acts may include the following:

- a. Mentors working on the software or hardware of student's robot(s) during the competition.
 - b. More experienced/advanced groups of students may provide advice but should not do the work for other groups. Otherwise, the team risks being disqualified.
2. RoboCupJunior reserves the right to revoke an award if fraudulent behavior is proven after the award ceremony occurs.
 3. Suppose it is evident that a mentor intentionally violates the code of conduct and modifies and works on the student's robot(s) during the competition. In that case, the mentor will be banned from future participation in RoboCupJunior competitions.
 4. Teams that violate the code of conduct can be disqualified from the tournament. Disqualifying a single team member from further participation in the tournament is also possible.
 5. Referees, officials, tournament organizers, and local law enforcement authorities will give a team a warning in less severe cases of violations of the code of conduct. A team can be disqualified immediately without warning for severe or repeated violations of the code of conduct.

2.6. Sharing

1. The spirit of world RoboCup competitions is that teams should share technological and curricular developments with other participants after the tournament. Sharing furthers the mission of RoboCupJunior as an educational initiative.
2. The RoboCupJunior Rescue Committee may publish developments on the RoboCupJunior website after the event.
3. Participants are strongly encouraged to ask questions to their fellow competitors to foster a culture of curiosity and exploration in the fields of science and technology.

3. Field

3.1. Description

1. The field layout will consist of a collection of tiles with a horizontal floor, a perimeter wall, ramps, and walls within the field.
2. All tiles are defined as a 30 cm x 30 cm space.
3. All walls used to create the maze are at least 15 cm high from any floor or the peaks of stairs, 30 cm in length, and are mounted on the edges of the tiles.
4. Tiles will be used as ramps. They will have an incline with a maximum of 25 degrees from the horizontal and are always straight.
5. **Ramps must NOT have a drop-off immediately following a rise section, creating a peak-like structure, or vice versa.**

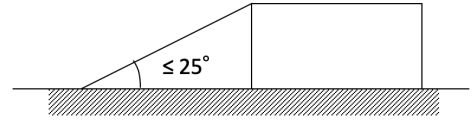
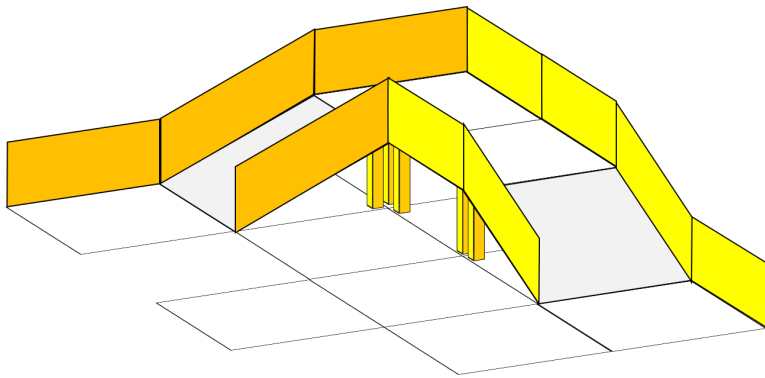

3.2. Floor

1. Floors may be either smooth or textured (like linoleum or carpet) and may have deviations of up to 3 mm in height between the tiles. There may be holes in the floor (approximately 5 mm in diameter) for fastening walls.
2. Colored tiles:
 - a. There will be tiles of different colors on the floor of the maze. The meaning of each color is explained below.
 - b. Coloured tiles will be placed randomly at the start of each game.
 - c. The organizers will fix colored tiles to the floor, but teams should be prepared for slight movements of these tiles.
3. Black tiles in the field represent holes, which the robot must avoid.
4. Silver tiles in the field represent checkpoints.
5. Blue tiles:
 - a. Blue tiles in the field represent puddles or other hard-to-traverse terrains.
 - b. If a robot visits a blue tile, it has to stop for 5 consequent seconds before visiting another tile.
6. Robots must be designed to navigate under tiles that form bridges over other tiles. Tiles placed above other tiles will be supported by walls. The minimum height (space between the floor and the ceiling) will be 25 cm.

3.3. Path

1. Tiles that lead to the starting tile consistently following the leftmost or rightmost wall are called 'linear tiles'. The tiles that do NOT lead to the starting tile consistently following the leftmost or rightmost wall are called 'floating tiles'.
2. Black tiles will affect the determination of tile type (linear or floating) since they can be considered virtual walls.

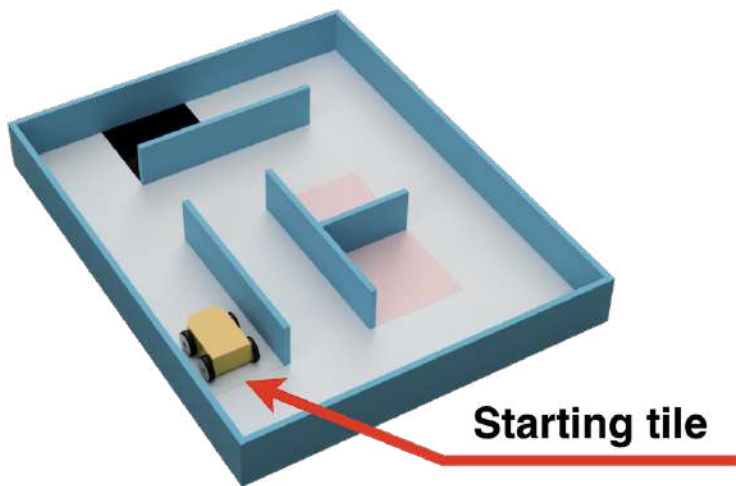

Linear tile



Floating tile

※The color and wall configurations are for illustration only.

3. Teams must prepare for the pathways to be slightly smaller in dimension ($\pm 10\%$ variation on the tile size) than a tile due to the nature of placing walls.
4. Pathways for the robot are intended to be of the width of the tile and may open into foyers more expansive than the pathways.
5. One tile is the starting tile, where a robot should start and exit the run. It can be located anywhere in the field.
6. Walls may be removed, added, or changed just before a scoring run starts to prevent teams from pre-mapping the layout of the fields. Organizers will do their best not to change the maze's length or difficulty when introducing these changes.

3.4. Speed Bumps, Obstacles, and Stairs

[1]

1. Speed bumps are fixed to the floor and have a maximum height of $1^{[2]}$ cm.
2. **Speed bumps are not allowed to be placed on ramps or stairs.**
3. Obstacles:
 - a. have a minimum height of 15 cm.
 - b. may consist of any large, heavy items.
 - c. may be fixed to the floor.
 - d. may be any shape.
4. Organizers may place obstacle either:
 - a. at least 20 cm from any wall OR
 - b. touching any wall and at least 20 cm from the opposite edge of the tile and any other obstacles.
5. Obstacles that are moved or knocked over must remain where they are moved or fall and will not be reset during the scoring run.
6. The width of the stairs is the same as the path. The maximum height is 2 cm. The length of the top of the stairs is at least 15 cm.

7. The incline of stairs (i.e., the angle of a plate to the horizontal when placed on the stairs) will be less than 25 degrees outside the dangerous zone.
8. **Stairs may be used to change the level of the floor, similar to a ramp.**
9. Stairs will be placed between walls.

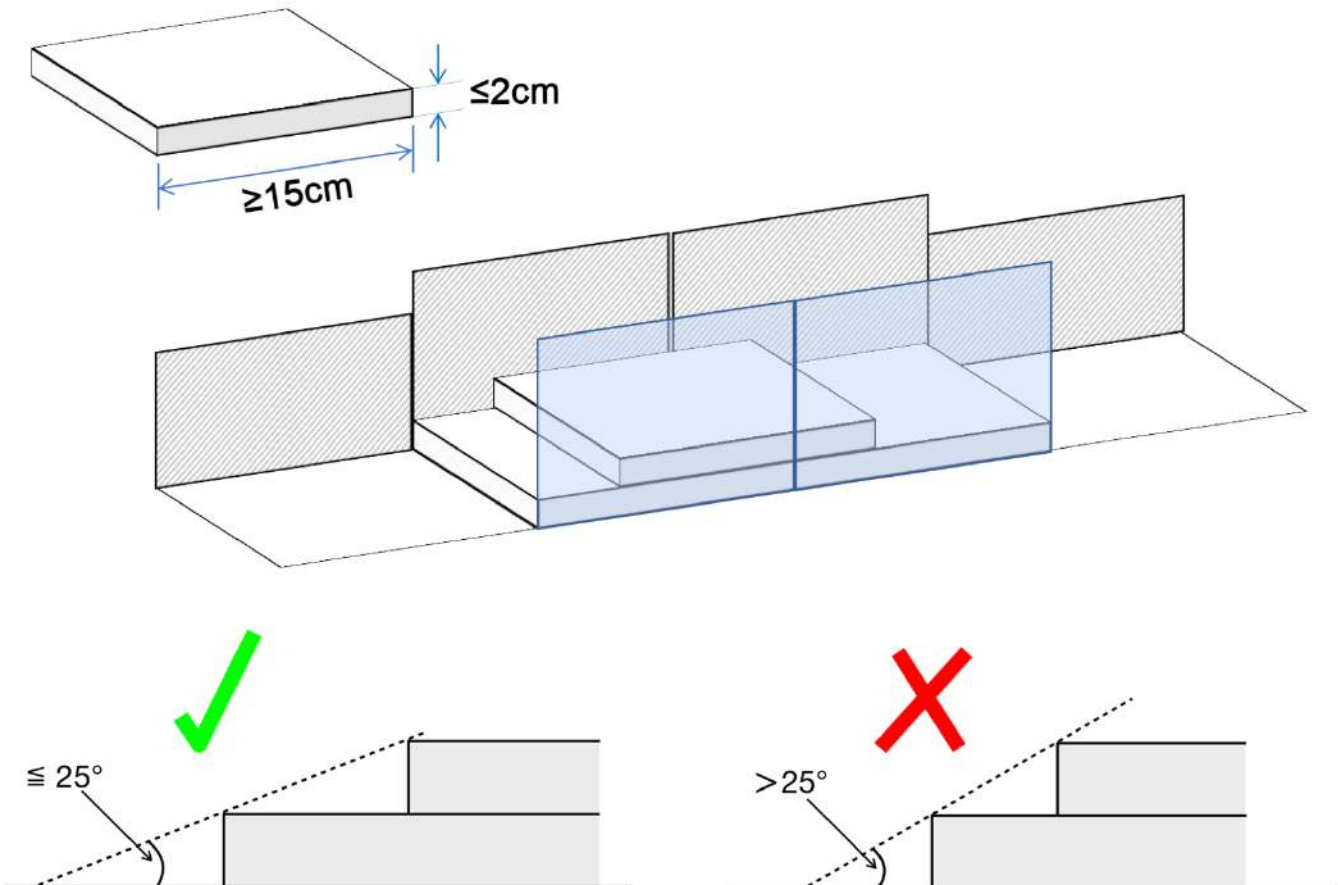

3.5. Dangerous Zone

1. The Dangerous Zone is an area considered more challenging than the rest of the field.
2. The Dangerous Zone is marked by a red tile at the entrance and completely surrounded by walls.
3. The Dangerous Zone does not block the path for completing the entire map. Therefore, the rest of the field can be completed without entering the Dangerous Zone.
4. Speed bumps are allowed to be placed on ramps.
5. The debris is not fixed to the floor and has a maximum height of 1 cm.
6. The incline of stairs (i.e., the angle of a plate to the horizontal when placed on the stairs) will be less than 30 degrees inside the dangerous zone.
7. Speed bumps are fixed to the floor and have a maximum height of 2 cm.
8. The start tile will not be inside the Dangerous Zone.

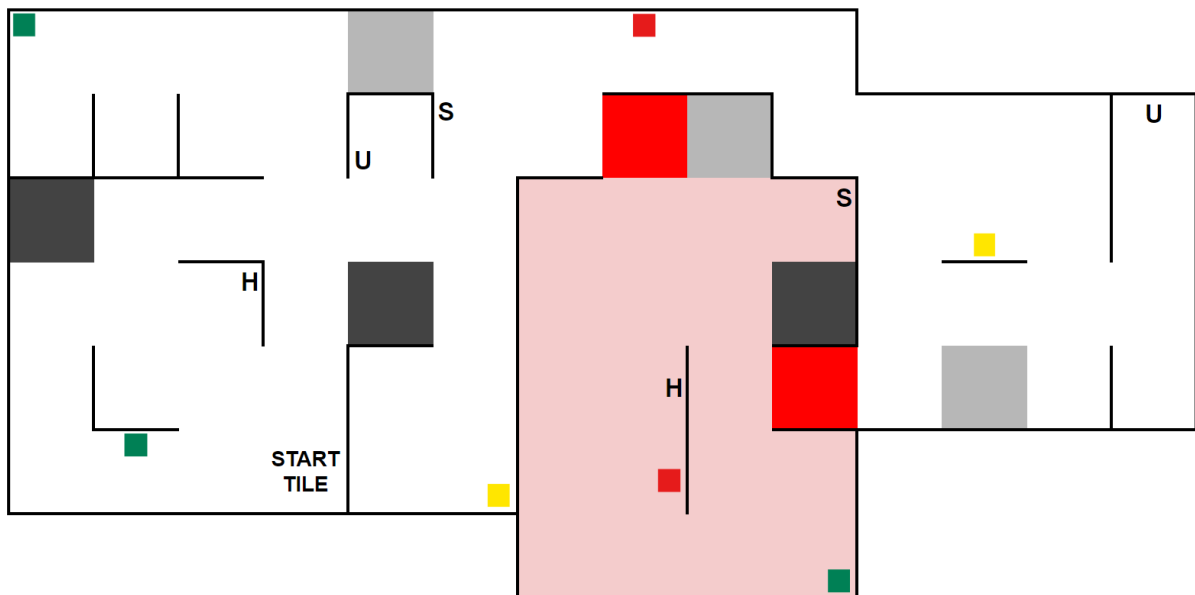

The tiles inside the dangerous zone won't be red (except for the entrance), this is just for illustration purposes.

3.6. Victims

1. There are two types of victims: letter victims and colored victims.
2. Victims are located near the floor of the field (located about 7 cm above the floor, see the figure below).

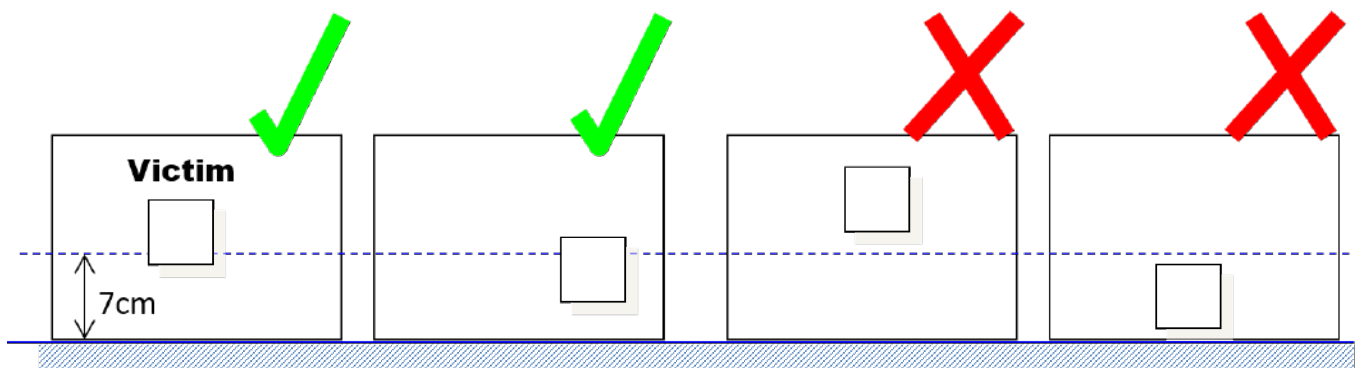

3. Organizers will never locate victims on walls facing black/silver/blue tiles, tiles with obstacles/speedbumps/stairs, and ramps.
4. There may be objects that resemble victims in appearance but are not victims. This includes but is not limited to letters, symbols or colors other than the ones described on this section. Such objects should not be identified as victims by robots.
5. Letter victims are uppercase letters printed on or attached to the wall. They are printed in black, using a sans serif typeface such as 'Arial'. They can be rotated, and their height will be 4 cm. The letters represent the health status of the victim.
 - a. Harmed victim: H
 - b. Stable victim: S

c. Unharmful victim: U

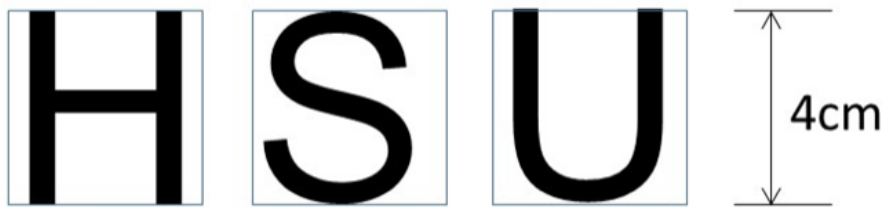

6. Colored victims are printed on or attached to a wall. Their size will be 16 cm² with no more than 6 cm in either dimension. Three colors are used: red, yellow, and green.

3.7. Rescue Kits

1. A rescue kit represents an essential health package distributed to a victim caught in a natural disaster. It symbolizes tools, medical supplies, or devices used in the rescue process, such as GPS transponders or even something as simple as a light source.
2. Because we need to ensure that a rescue kit reaches the victim, it has to stay near the victim after the deployment. For example, it cannot roll away from or bounce away from the victim.
3. Each rescue kit must have a minimum size of 1 cm in each dimension and have a minimum volume of 1 cm³ after deployment.
4. A robot can only carry a maximum number of 12 rescue kits.
5. Each team is responsible for its rescue kit system, including bringing the rescue kits to the competition. The team captain is responsible for loading the rescue kits onto their robot and collecting it from the field with the referee's authorization after the end of the run.
6. Deployment of the rescue kit must be very clear to the referee.

3.8. Environmental Conditions

1. The environmental conditions at a tournament may differ from those at home practice fields. Teams must come prepared to adjust their robots to the conditions at the venue.
2. Lighting and magnetic conditions may vary in the rescue field.
3. The field may be affected by magnetic fields (e.g., under-floor wiring and metallic objects). Teams should prepare their robots to handle such interference.
4. The field may be affected by unexpected lighting interference (e.g., camera flash from spectators). Teams should prepare their robots to handle such interference.
5. The RoboCupJunior Rescue Committee will try its best to fasten the walls onto the field floor so that the impact from contact should not affect the robot.
6. All measurements in the rules have a tolerance of $\pm 10\%$.
7. Objects detected by the robot will be distinguishable from the environment by their color or shape.

4. Robots

4.1. Terms and Definitions

1. **Tool:** The term "tool" is a comprehensive concept that encompasses both hardware and software components essential for the operation of robots. These can include physical components such as sensors, actuators, or controllers, as well as software elements like algorithms or libraries.
2. **Calibration:** Calibration refers to the process in which a team intervenes to adjust or fine-tune the settings of a tool.
3. **Development:** Development refers to activities aimed at creating new solutions, technologies, or systems, as well as enhancing existing ones through innovation and creative problem-solving. In this case, for example, calibration is not considered development since it involves fine-tuning or configuring an existing system without introducing new features, technological advancements, or innovations.
4. Tools are allowed as long as they are developed by the team or when they cannot independently complete a task, or a part of a task, that enables the robot to earn points by sending a signal to the controller without further development (e.g., color sensors, cameras, or libraries necessary for sensor operation).
5. Tools which are not developed by the team, which can independently complete a task, or a part of a task, which enables the robot to earn points by sending a signal to the controller without further development (e.g., line-following sensors, AI cameras, OCR libraries) are prohibited.

4.2. Control

1. Robots must be controlled autonomously. Using a remote control, manual control, or passing information (by external sensors, cables, wirelessly, etc.) to the robot is not allowed.
2. Robots must be started manually by the team captain.
3. Robots may utilize various maze navigation algorithms. Any pre-mapped type of dead reckoning (movements preprogrammed based on known locations or placement of features in the field) is prohibited.
4. A robot must not damage any part of the field in any way.

4.3. Construction

1. The height of a robot must not exceed 25 cm.
2. Robots may not have sensors or devices that enable them to 'see' over the walls.
3. Any robot kit or building blocks, either available on the market or built from raw hardware, may be used as long as the design and construction of the robot are primarily and substantially the students' original work.
4. **Robots like drones or hovercrafts are prohibited in the challenge due to safety reasons.**

5. Teams are not permitted to use commercially produced robot kits or sensor components specifically designed or marketed to complete any single primary task of RoboCupJunior Rescue. Robots that do not comply will face immediate disqualification from the tournament. If there is any doubt, teams should consult the RoboCupJunior Rescue Committee before the competition.
6. Only lasers from classes 1 and 2 are allowed for the safety of participants and spectators. The organizers will check this during the inspection. Teams using lasers must have the datasheet of the laser and submit them before the competition and be able to show them during the competition.
7. Robots may incur damage by falling off the field, making contact with another robot, or contacting field elements. The RoboCupJunior Rescue Committee cannot anticipate all potential situations where damage to the robot may occur. Teams should ensure that all active elements on a robot are adequately protected with resistant materials. For example, teams must protect electrical circuits from all human contact and direct contact with other robots and field elements.
8. When batteries are transported, moved, or charged, it is strongly recommended that safety bags be used. Reasonable efforts should be made to ensure that robots avoid short circuits and chemical or air leaks.
9. **Robots must be equipped with a handle that is to be used to pick them up during the scoring run.**
10. **Robots must be equipped with a single physical binary switch/button (with exception of buttons that are a part of commercial controller), clearly visible to the referee, for starting the robot at the beginning of the run and when a lack of progress occurs. The procedure performed after a LoP occurs can only include this button and at most one more switch for cutting the power. Teams have to notify the referee about their LoP procedure before each scoring run, and only this procedure is allowed to be performed after a LoP.**
11. **The robot must be equipped with one specific LED or display that is dedicated only for identifying victims. The LED or display must be clearly visible to the referee.**

4.4. Team

1. Each team must have only one robot in the field.
2. Each team must comply with the [RoboCupJunior General Rules](#) regarding the number of members and each member's age.
3. Each team member must explain their work and have a specific technical role.
4. A student can be registered on only one team across all RoboCupJunior leagues/sub-leagues.
5. A team can only participate in one league/sub-league across all RoboCupJunior leagues/sub-leagues.
6. Mentors/parents are not allowed to be with the students during the competition. The students will have to govern themselves (without a mentor's supervision or assistance) during the long stretch of hours at the competition.

4.5. Inspection

1. A panel of referees will scrutinize the robots before the start of the tournament and at other times

during the competition to ensure that they meet the constraints described in these rules.

2. Using a robot similar to another team's robot from a previous year or the current year is illegal.
3. The team's responsibility is to have their robot re-inspected if modified at any time during the tournament.
4. Students will be asked to explain their robot's operation to verify that its construction and programming are their own work.
5. Students will be asked about their preparation efforts. The RoboCupJunior Rescue Committee may request them to answer surveys and participate in videotaped interviews for research purposes.
6. All teams must complete a web form before the competition to allow referees to prepare better for the interviews. The RoboCupJunior Rescue Committee will provide instructions on submitting the form to the teams at least 4 weeks before the competition.
7. All teams have to submit their source code before the competition. The organizers will not share the source code with other teams without the team's permission. The organizers will request permission at the registration.

4.6. Violations

1. Any violations of the inspection rules will prevent the offending robot from competing until modifications are made, and the robot passes inspection.
2. Teams must make modifications within the schedule of the tournament, and teams cannot delay tournament play while making modifications.
3. Suppose a robot fails to meet all specifications (even with modifications). In that case, it will be disqualified from that game (but not from the tournament).
4. No mentor assistance is allowed during the competition. (See [Section 2, "Code of Conduct"](#))
5. Any rule violations may be penalized by disqualification from the tournament or the game or result in a loss of points at the discretion of the referees, officials, or RoboCupJunior Rescue Committee.

5. Play

5.1. Pre-game Practice

1. When possible, teams will have access to practice fields for calibration and testing throughout the competition.
2. Whenever there are dedicated independent fields for competition and practice, it is at the organizers' discretion if testing is allowed on the competition fields.

5.2. Humans

1. Teams should designate one of their members as 'captain' and another as 'co-captain'. Only these two team members will be allowed access to the competition fields unless directed by a referee. Only the

captain can interact with the robot during a scoring run.

2. The captain can move the robot only when they are told to do so by a referee.
3. Other team members (and any spectators) within the vicinity of the competition field must stand at least 150 cm away from the field unless directed by a referee.
4. No one is allowed to touch the fields intentionally during a scoring run.
5. All pre-mapping activities will immediately disqualify the robot for the round. Pre-mapping is the act of humans providing the robot with information about the field (e.g., location of walls, location of silver/black/blue tiles, location type of victims, etc.) before the game.

5.3. Start of Game

1. Each team has a maximum of 8 minutes for a game. The game includes the time for calibration and the scoring run.
2. Calibration is defined as taking sensor readings and modifying a robot's program to accommodate such sensor readings. Calibration does not count as pre-mapping.
3. The scoring run is defined as the time when the robot is moving autonomously to navigate the field, and the referee will record the scores.
4. A game begins at the scheduled starting time, whether or not the team is present or ready. Start times will be posted around the venue.
5. Once the game has begun, the robot is not permitted to leave the competition area.
6. Teams may calibrate their robot in as many locations as desired on the field, but the clock will continue to run. Robots are not permitted to move on their own while calibrating.
7. Before a scoring run begins, the referee will roll a standard 6-sided dice or another method of randomization set by the organizers to determine the location of the black, blue, and silver tiles. Organizers will not reveal the position of the black, blue, and silver tiles to the team until they are ready to start a scoring run (see [4.3.11](#)). Referees will ensure the combination of black tile placements in a field layout is 'solvable' before a robot begins a scoring run.
8. Before a scoring run begins, the referee can change any walls of the field (see [2.3.6](#)).
9. Once a team is ready to start a scoring run, the team must notify the referee. To start a scoring run, the robot is placed on the start tile of the course, as indicated by the referee. Once a scoring run has begun, no more calibration is permitted, including changing code/code selection.
10. Teams may choose not to calibrate the robot and immediately start the scoring run instead.
11. Once the robot starts moving as the scoring run begins, a referee will place the black, blue, and silver tiles.

5.4. Scoring Run

1. Modifying the robot during a scoring run is prohibited, which includes remounting parts that have fallen off.
2. Any parts the robot loses intentionally or unintentionally will be left on the field until the game ends.

Team members and referees cannot move or remove elements from the field during a scoring run.

3. Teams cannot give their robot any information about the field. A robot is supposed to recognize the field elements by itself.
4. A 'visited tile' means that more than half of the robot is inside the tile when looking from above.

5.5. Lack of Progress

1. A lack of progress occurs when:
 - a. the team captain declares a lack of progress.
 - b. a robot visited the black tile. See the definition of visited tile on [4.4.4](#).
 - c. a robot visits another tile without stopping for 5 consequent seconds after visiting a blue tile. See the definition of visited tile on [4.4.4](#).
 - d. a robot damages the field.
 - e. a team member touches the field or their robot without permission from a referee.
2. In the event of a lack of progress, the robot must return to the last visited checkpoint (or the start tile if it never reached a checkpoint). The robot can be installed in any direction. For the definition of the visited tile (see [4.4.4](#)).
3. After a lack of progress, only the LoP procedure explained to the referee before the run start is allowed to be performed (see [3.3.10](#)).

5.6. Scoring

1. To successfully identify a victim, the robot must stop within 15 cm of a victim and blink **with the specific LED or Display (see 3.3.11) that is clearly** ^[3] visible to the referee for the full 5 seconds while stationary. **The blink interval (ON: 500ms, OFF: 500ms) must be followed to successfully identify a victim.**
2. Points are rewarded for each Successful Victim Identification in the field.
 - a. For victims located on a linear tile.
 - i. For colored victims: 5 points
 - ii. For letter victims: 10 points
 - b. On floating tiles
 - i. For colored victims: 15 points
 - ii. For letter victims: 30 points

Floating tile
 Linear tile
 Black hole
 ▶ Starting tile
 $\overset{5}{15}$ Colored victims
 $\overset{10}{30}$ Letter victims

Colored victims

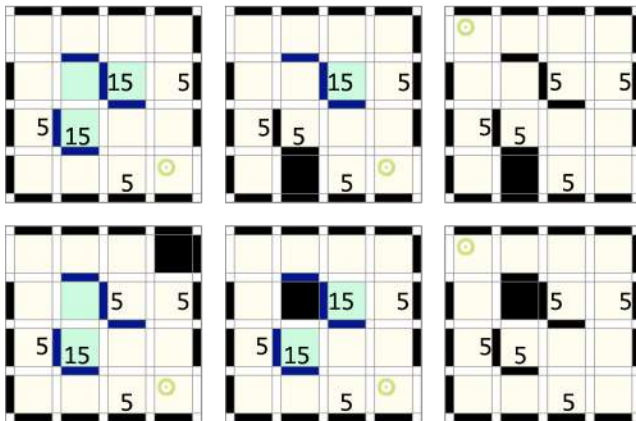

Letter victims

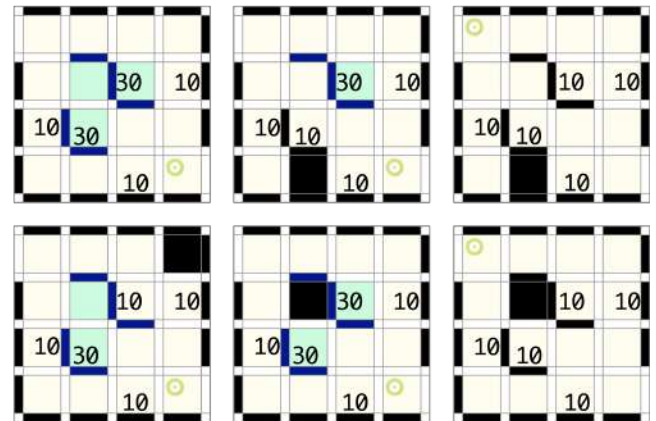

The color in the figure is for illustration only. Some tiles change between floating or linear depending on the adjacent black tiles. The field designer must remember this rule when deciding on the location of the black tiles. They can be changed during the run via a dice roll to keep the maximum score consistent.

3. A robot must deploy a rescue kit entirely within 15 cm of the victim to successfully deploy a rescue kit. The deployment point is determined by the location of the rescue kit when the robot moves entirely out of the 15 cm boundary of the victim.
4. No points will be awarded for delivering a rescue kit to a victim that wasn't successfully identified first.
5. 10 points are awarded per successful rescue kit deployment. The robot can score the following amount of rescue kits points:
 - a. Letter victims:
 - i. Harmed (H): two rescue kits per victim. (Maximum points for rescue kit deployment per victim: 20 points.)
 - ii. Stable (S): one rescue kit per victim. (Maximum points for rescue kit deployment per victim: 10 points.)
 - iii. Unharmed (U): zero rescue kit per victim.
 - b. Coloured victims:
 - i. Red: two rescue kits per victim. (Maximum points for rescue kit deployment per victim: 20 points.)
 - ii. Yellow: one rescue kit per victim. (Maximum points for rescue kit deployment per victim: 10 points.)
 - iii. Green: zero rescue kits per victim.
6. The Reliability Bonus is a non negative number and consists of the number of successful victim identifications (SVI), successful rescue kit deployments (SRD) and a deduction for the total number of Lack of Progresses (LoP) as such:

$$(\text{RELIABILITY BONUS}) = (\text{SVI}) \times 10 + (\text{SRD}) \times 10 - (\text{LoP}) \times 10$$

7. Successful Speed Bump Crossing. For each tile with speed bumps passed, a robot is awarded 5 points.
8. Successful Up or Down Ramp Navigation. A robot is awarded 10 points for successfully navigating up or down a ramp (i.e., the robot can score a maximum of 10 points per ramp). The robot has successfully navigated through the ramp when it moves from the bottom to the top tile (or vice-versa) and is entirely within the horizontal tile without toppling over.
9. Successful Stair Navigation. A robot is awarded 5 points for navigating **up or down the stairs** ^[4] (i.e., the robot can score a maximum of 5 points per **direction (up or down)** ^[5]). Successful navigation means the robot moves from the bottom tile on one side of the stairs to the top tile **(or vice-versa) and is entirely within the horizontal tile without toppling over.** ^[6]
10. Successful Checkpoint Navigation. A robot is awarded 10 points for each visited checkpoint. Refer to [4.4.4](#) for definition of visited tile.
11. Successful Exit Bonus. A robot is awarded 10 points for each victim successfully identified (see [4.6.1](#)). **The 'exit bonus' condition is satisfied when the robot returns to the starting tile. On the starting tile, the robot has to blink (ON: 1s, OFF: 1s) with the same LED or display that is used to identify a victim (see [3.3.11](#)) for at least 10 seconds.** ^[7]
12. No duplicate rewards. For example, suppose a robot successfully crosses a tile with speed bumps multiple times. In that case, only one successful speed bump crossing will be rewarded per tile. The same result applies to all other scoring rules.
13. Misidentification. If a robot identifies a victim through methods outlined in [4.6.1](#) but is outside the 15 cm radius of any victim, 5 points will be deducted. This scenario doesn't apply to delivering the incorrect number of rescue kits to victims. The total points will never go below zero points.

5.7. End of Game

1. A team may elect to stop the game early at any time. In this case, the team captain must indicate the team's desire to terminate the game to the referee. The team will be awarded all points earned up to the call for the end of the game. The referee will stop the time at the end of the game, which will be recorded as the game time.
2. The game ends when:
 - a. the 8 minutes of allowed game time expires
 - b. the team captain calls the end of the game
 - c. the robot returns to the start tile and is awarded the exit bonus

6. Competition

This chapter outlines the structure of an international RoboCupJunior Rescue competition. The competition format and the inclusion of elements like rubrics based scoring, Technical Challenges and the SuperTeam Challenge may vary in local, regional and super-regional competitions. Please refer to

the respective organiser for details.

6.1. Rounds & Scoring

1. The competition will consist of multiple rounds of which the worst one or more will be omitted from the final score. The worst round is defined by the lowest normalized field score of the team.
2. The field score for every round will be normalized with the score of the best team of that round:

$$(\text{NORMALIZED FIELD SCORE}) = (\text{FIELD SCORE}) / (\text{BEST FIELD SCORE})$$

3. The normalized field scores will be used to calculate the mean. The worst round(s) will not be considered here:

$$(\text{MEAN OF NORMALIZED FIELD SCORES}) = (\text{SUM OF NORMALIZED FIELD SCORES EXCLUDING OMITTED ROUNDS}) / (\text{NUMBER OF ROUNDS} - \text{NUMBER OF OMITTED ROUNDS})$$

4. The normalized rubrics score is made up of a sum of normalized scores for the individual rubrics as follows:

$$\begin{aligned} (\text{NORMALIZED RUBRICS SCORE}) = & \\ & 0.6 \times (\text{TDP SCORE}) / (\text{BEST TDP SCORE}) \\ & + 0.2 \times (\text{VIDEO SCORE}) / (\text{BEST VIDEO SCORE SCORE}) \\ & + 0.2 \times (\text{POSTER SCORE}) / (\text{BEST POSTER SCORE}) \end{aligned}$$

5. The Rubrics for TDP, **Video**^[8] and Poster will be available on the RoboCupJunior website and the RCJ Rescue Community website.
6. The score from the Technical Challenge will be normalized with the score of the best team:

$$(\text{NORMALIZED TECHNICAL CHALLENGE SCORE}) = (\text{TECHNICAL CHALLENGE SCORE}) / (\text{BEST TECHNICAL CHALLENGE SCORE})$$

7. The final score is made up of a weighted sum of normalized scores from the field score, the rubrics and the Technical Challenge as such:

$$\begin{aligned} (\text{TOTAL SCORE}) = & \\ & 0.6 \times (\text{MEAN OF NORMALIZED FIELD SCORES}) \\ & + 0.2 \times (\text{NORMALIZED RUBRICS SCORE}) \\ & + 0.2 \times (\text{NORMALIZED TECHNICAL CHALLENGE SCORE}) \end{aligned}$$

8. Ties in scoring will be resolved based on the mean of normalized field scores.

6.2. Technical Challenge

The Technical Challenge is an additional part of the competition where the teams' ability to quickly modify the behaviour of their robot will be tested. It consists of one or more mini-tasks with only a limited timespan to solve.

1. The Technical Challenge will take place after the scoring runs have ended.
2. The rules of the individual parts of the Technical Challenge will not be announced before the competition. The teams will only have limited time to prepare for the Challenge.
3. The timeframe for the completion of these tasks will be announced alongside the rules and scoring at a team meeting after the scoring runs.
4. The rules will require the teams to reprogram their robot to change its behaviour. There will be no hardware changes required compared to the main scoring runs.
5. The time given will correspond to the difficulty level of the tasks.
6. **Any external contact during the Technical Challenge is prohibited; non-team members are not allowed to take place on the competition area or to help the competitors remotely.**

6.3. SuperTeam Challenge

The SuperTeam Challenge takes place independently of the main competition and won't influence the team's individual score. It has its own award and is focussed on the cooperation between the teams.

1. Each SuperTeam will consist of at least two teams. Teams coming from regions that share a native language will not be part of the same SuperTeam.
2. The rules of the SuperTeam Challenge will be announced at the competition and require the teams of each SuperTeam to work together.
3. The SuperTeam Challenge will require substantial software changes and may require minor hardware adjustments.



It is highly recommended that teams bring some kind of communication hardware or think about a communication mechanism for this challenge.

7. Open Technical Evaluation

7.1. Description

1. The organizers will evaluate your technical innovation during a dedicated time frame. All teams need to prepare for an open display during this time frame.
2. Judges will circulate and interact with the teams. The Open Technical Evaluation is intended to be a casual conversation with a question-and-answer atmosphere.
3. The Open Technical Evaluation's main objective is to emphasize the innovation's ingenuity.

Innovative may mean technical advances compared to existing knowledge or an out-of-the-ordinary, simple but clever solution to existing tasks.

7.2. Evaluation Aspects

1. A standardized rubric system will be used, focusing on:
 - creativity
 - cleverness
 - simplicity
 - functionality
2. Your 'work' can include (but is not limited to) one of the following aspects:
 - creation of your own sensor instead of a pre-built sensor
 - creation of a 'sensor module' which is comprised of various electronics resulting in a self-contained module to provide a specific functionality
 - creation of a mechanical invention that is functional but out of the ordinary
 - creation of a new software algorithm for a solution

7.3. Documents

1. Teams must provide documents that explain their work. Each invention must be supported by concise but clear documentation. The documents must show precise steps towards the creation of the invention.
2. The deadline for delivering the documents is scheduled for 3 weeks before the first day of the competition through an online form.
3. Documents must include one Technical Description Paper (TDP), one Poster and one **Video (see 6.3.7)**^[9]. Teams should be prepared to explain their work.
4. All teams must submit their TDP before the competition. The TDP is a public document that will be shared with the community. **The competition organizer will ask the team to fill out the web form or ask to submit a PDF file. All teams must strictly follow the guidance on the web form or, in the case of PDF submissions, strictly follow the template provided. If a team does not follow this guidance / template (including but not limited to the different sections, fonts, sizes and lengths) the score for the document will be 0 and is not going to be evaluated.**^[10] A template for the TDP and rubrics are available on the [RoboCupJunior Rescue Community Website](#).^[11]
5. All teams must submit a Poster file before the competition and bring a physical Poster to the competition venue. The Poster is a public document that will be shared with the community during the Poster Presentation session at the competition venue. The poster should include but is not limited to: the name of the team, country, league, robot description, robot capabilities, controller, the programming language used, sensors included, method of construction, time used for development, cost of materials, and awards won by the team in its country, etc. A guide for the poster format and rubrics are available on the [RoboCupJunior Rescue Community Website](#).



6. **All teams must create and submit a Video before the competition. The Video should be short and showcasing the work of the team. These videos will be presented during the competition and should summarize the key aspects of the team's project, design process, and innovations. A guide for the video format and rubrics are available on the [RoboCupJunior Rescue Community Website](#).**

7.4. Sharing

1. Teams are encouraged to review others' posters, TDPs and presentations.
2. Teams awarded certificates must post their documents and presentation online when the RoboCupJunior Rescue Committee asks.

8. Conflict Resolution

8.1. Referee and Referee Assistant

1. All decisions during gameplay are made by the referee or the referee assistant, who are in charge of the field, persons, and objects surrounding them.
2. During gameplay, the decisions made by the referee or the referee assistant are final.
3. After gameplay, the referee will ask the captain to sign the score sheet. Captains will be given a maximum of 1 minute to review the score sheet and sign it. By signing the score sheet, the captain accepts the final score on behalf of the entire team. In case of further clarification, the team captain should write their comments on the score sheet and sign it.

8.2. Rule Clarification

1. If any rule clarification is needed, please contact the [International RoboCupJunior Rescue Committee](#) through the [RoboCupJunior Forum](#).
2. If necessary, even during a tournament, a rule clarification may be made by members of the [International RoboCupJunior Rescue Committee](#).

8.3. Special Circumstances

1. If particular circumstances, such as unforeseen problems or capabilities of a robot occurs, rules may be modified by the RoboCupJunior Rescue Committee Chair in conjunction with available committee members, even during a tournament.
2. Suppose team captains/mentors do not attend the team meetings to discuss problems, and the resulting rule modifications described at [7.3.1](#). In that case, the organizers will understand that they agreed and were aware of the changes.

[1] In previous version this said "Speed Bumps, Debris, Obstacles, and Stairs"

[2] In previous version this said "2"

[3] In previous version this said "an indicator"

[4] In previous version this said "a set of stairs in either direction"

[5] In previous version this said "set of stairs"

[6] In previous version this said "and then onto the bottom tile on the other side of the stairs without assistance"

[7] In previous version this said "The 'exit bonus' condition is satisfied when the robot returns to the starting tile and stays there for at least 10 seconds to complete the scoring run."

[8] In previous version this said "Engineering Journal"

[9] In previous version this said "Engineering Journal"

[10] In previous version this said "TDP should describe your team's project planning, robot's mechanical and electronics design, your software architecture and solutions and, the applied process on performance evaluation."

[11] In previous version this said "Engineering Journals should demonstrate your best practices in the development process. A guide for the Engineering Journal format and rubrics are available on the [RoboCupJunior Official website](#)."